



SLS
SECURITY



SLS Gem Anti-lance (U.S. UL. TXTL. 60)
Unique six-sided protection against the Thermic Lance.

SLS Gem Anti-Lance Range

The SLS Gem Anti-Lance range of safes offers unique protection for the priceless.

It gives full six-sided protection against all forms of attack including the formidable Thermic Lance.

The safe door and body consist of sophisticated castings comprising of copper/zac nuggets, and stainless steel/zac nuggets, cast as an integral unit. This unique barrier matrix encases on six sides an additional material designed to resist the Thermic Lance. The minimum protective thickness is 6 1/8" / 156mm.

The safe has been independently tested by the Underwriters Laboratory Inc, Chicago against torch, tool and multiple explosive attack (UL TX TL60) and passed with a substantial margin of protection.

The Thermic Lance resistance of this unit is at least 12 times greater than that of any Bankers quality safe currently being manufactured.



SLS Thermic Lance Testing

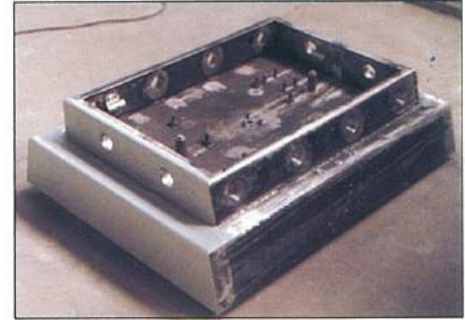

Massive Safe Door Fabrication



UL Torch/Tool Attack on Safe Door Jamb



One Piece Composite Body Casting



UL Explosive Testing

The SLS Gem Anti-Lance range has provision for locking by up to four locks, but dual locking is standard. A safe of this standard naturally includes in its basic specification a two movement 144hr time lock. A toughened glass nerve centre protects the

central locking mechanism from all forms of attack and activates multiple dead relocking devices which like the routing of the tube itself are in random positions. Live relocking devices come into operation each time the locks are operated.



The massive 4-way moving boltwork is similar to that of the SLS Treasury Range Anti-Lance Strong Room Doors and locks directly into the safe body, and when locked in position, causes the door to form an integral part of the safe body.

All the moving bolts are 2"/50mm diameter.

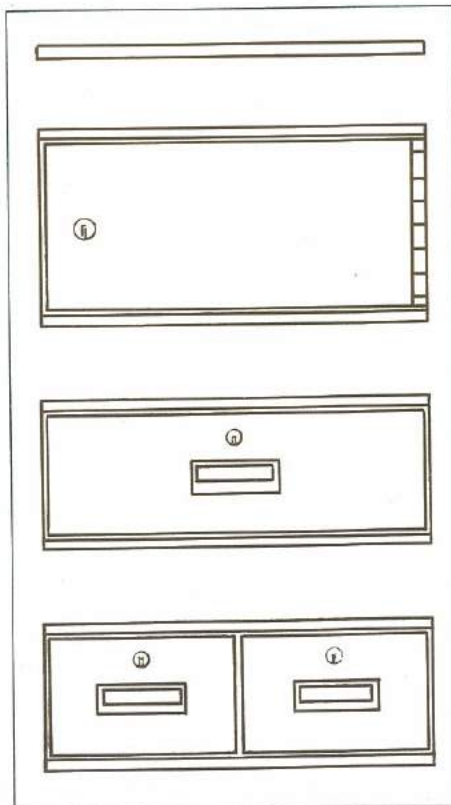

Adjustable shelves, and half width lockable drawers and cupboards are optional extras. The latter can be with deposit features and locking incorporating time delay locks.

The safe body is in an attractive dark hammer brown paint, the safe door in a contrasting light brown semi-matt enamel. A stainless steel facia panel completes the external finish.

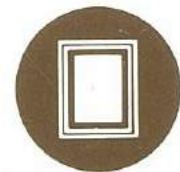

SLS
Security Lock & Safe Co Ltd
 London & Telford
 England

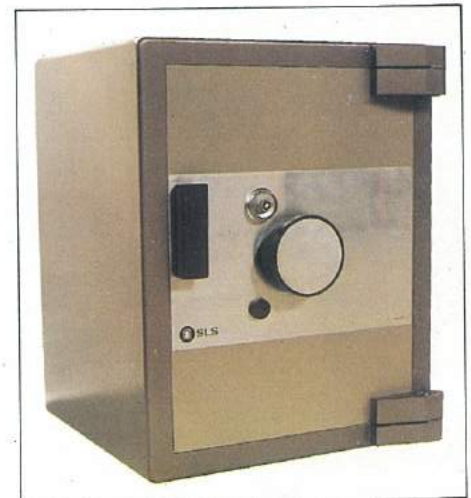

Gem Anti-Lance

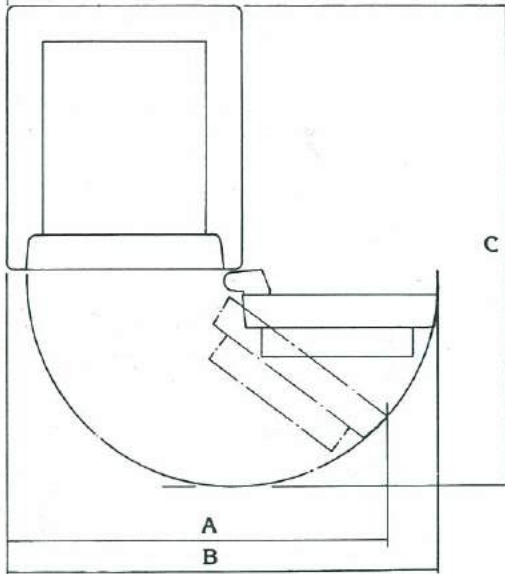

SIZE	A	B	C
	mm/ins		
ALL	1486	1753	1797
SIZES	58½	69	70¾

A = Minimum dimension for clear opening
 B = Overall width with door open at 180°
 C = Overall depth with door open at 90°

MODEL 6325

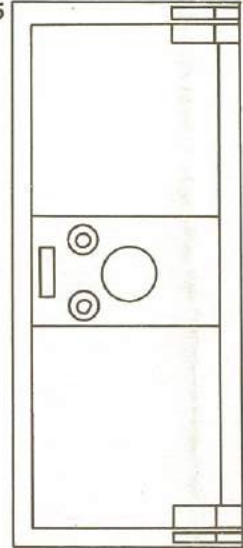

MODEL 5025

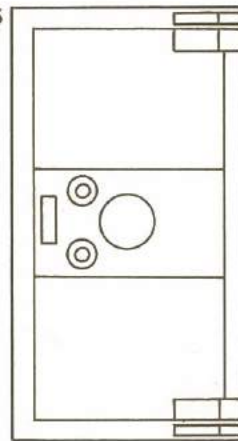

MODEL 3525

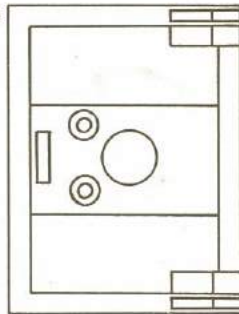

MODEL 2525

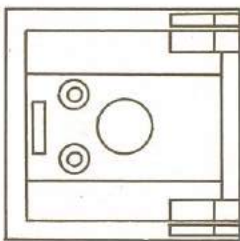

MODEL	INTERNAL mm/ins			EXTERNAL mm/ins			CUBIC CAPACITY m ³ /ft ³	WEIGHTS kg/lbs
	H	W	D	H	W	D		
2525	635	635	483	447	947	914	0.194	2677
	25	25	19	37¼	37¼	36	6.87	5900
3525	889	635	483	1200	947	914	0.272	3606
	35	25	19	47¼	37¼	36	9.62	7950
5025	1270	635	483	1581	947	914	0.389	6033
	50	25	19	62¼	37¼	36	13.74	13300
6325	1600	635	483	1911	947	914	0.491	6925
	63	25	19	75¼	37¼	36	17.32	15260

ADD 80mm FOR TOTAL DEPTH OVER HINGES.

SLS reserve the right to alter the specification without notice in the interest of improving security.

All dimensions and weights are nominal.

As a matter of policy all heavy range safes are of similar external appearance and there is therefore no indication as to the likely value of the contents.